

Varenummer: 03550050

Beskrivelse: Fluro hydraulik ledhoved FPR 50S

Mål

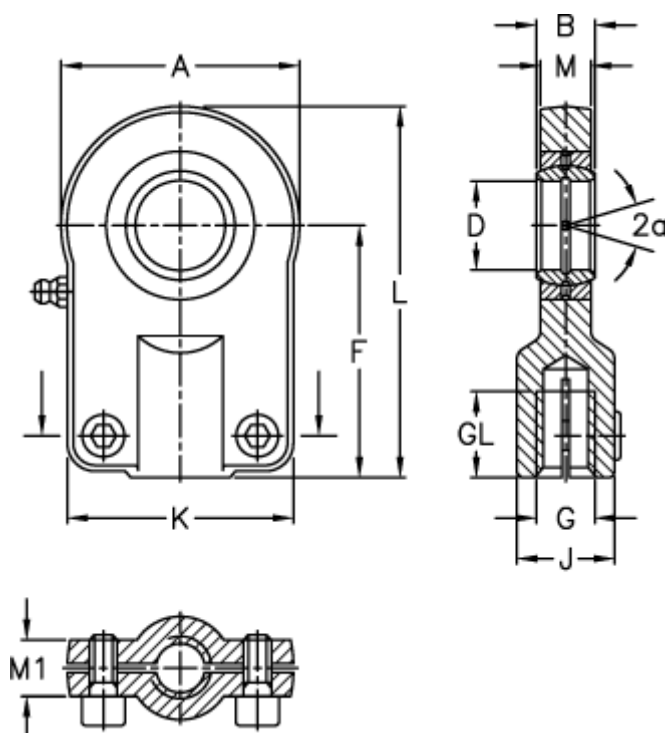

A	= 120	J	= 55
a (grader)	= 6	K	= 105
B	= 35	L	= 190
D	= 50	M	= 30
Dynamisk belastning C (kN)	= 156	M1	= 30
F	= 130	Moment (Nm)	= 86
g	= M33x2	Statisk belastning C0 (kN)	= 245
GL	= 46	Vægt	= 4400